

自由勾配側溝（街路用）

本体（水路幅300~400mm）

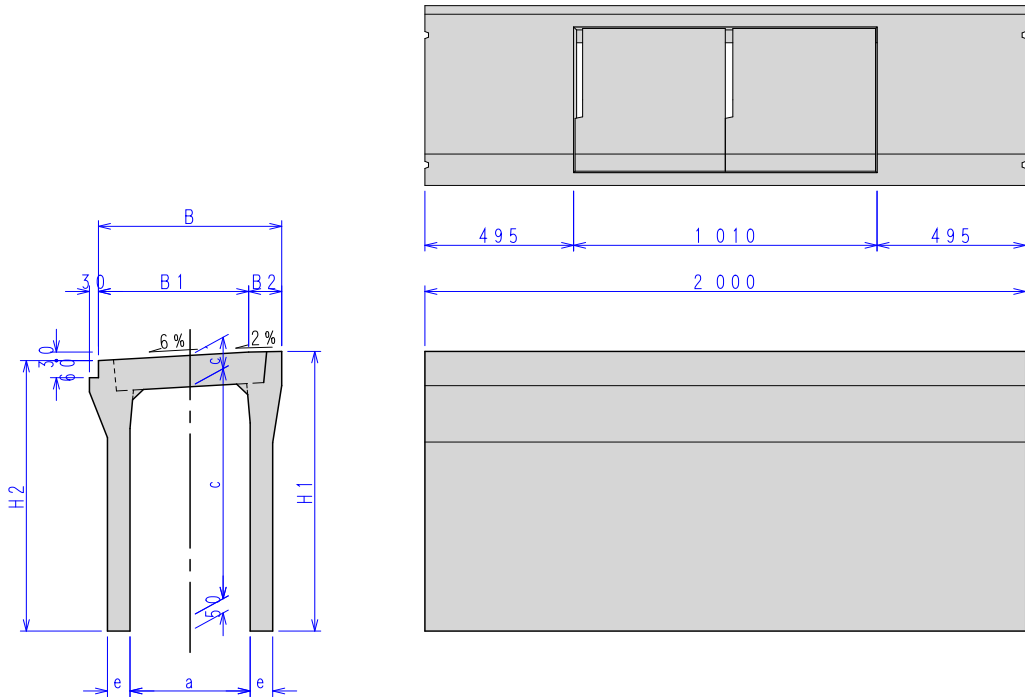

■寸法・重量

呼び名	寸法 (mm)									参考重量 (kg)					
	B	B1	B2	H1	H2	a	c	c'	e						
300×300	440	500	-	465	435	300	300	445	55	380					
400				565	535		400		60	449					
500				665	635		500		70	505					
600				765	735		600		80	615					
700				865	835		700		90	680					
800				965	935		800		80	820					
900				1065	1035		900		80	895					
1000				1165	1135		1000		90	1,060					
1100				1265	1235		1100		90	1,140					
400×400				610	500		110		580	547	400	400	560	60	510
500									680	647		500		65	590
600	780	747	600			75		655							
700	880	847	700			75		780							
800	980	947	800			85		850							
900	1080	1047	900			85		1,000							
1000	1180	1147	1000			95		1,080							
1100	1280	1247	1100			95		1,260							
1200	1380	1347	1200			95		1,350							

蓋版（水路幅300~400mm）

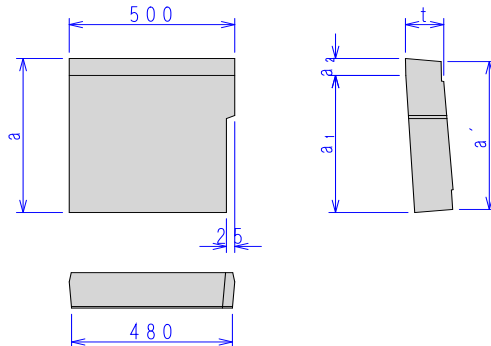

■寸法・重量

呼び名	寸法					参考重量 (kg)
	a	a'	a1	a2	t	
300用	400	380	400	-	100	43
400用	500	480	445	55	115	63